



GS-200 SERIES

Ultra performance CNC Turning Centers

GOODWAY MACHINE CORP.

ULTRA PERFORMANCE CNC TURNING CENTERS

Packed with industry leading technology and top quality components, the Goodway GS-200 series turning centers combine incredible power, strength, and speed to bring you The Ultimate Machining Power®. These powerful ultra performance machines will easily accomplish the demanding turning applications of today and tomorrow. 2 bed lengths (utilizing the same advanced design) and 3 spindle sizes offer a total of 6 basic model configurations to suit your application. Furthermore, with available live tooling, C-axis, Y-axis, and sub-spindle capabilities, milling, drilling, and front / back-end turning applications may be completed in one single machine.

- ▶ 30° ture slant-bed design provides smooth chip disposal and easier operator access.
- ▶ Stainless steel way covers and special steel wipers molded with industrial strength rubber are used for durability.
- ▶ Fully enclosed splashguards keep chips and coolant contained for a safe clean working environment.
- ▶ The auto lubrication system delivers metered amounts of lubrication to the slide ways, ball screws, and vital components. Distribution is automatically shut off during idling to prevent waste.



(GS-260 model shown with optional accessories)

Chuck Size	8" Chuck	10" Chuck	10" Chuck (Big- bore)
Bar Capacity	2.0" Bar Capacity	2.5" Bar Capacity	3.0" Bar Capacity
Turning Length 24.5" (600 mm) ^{*1}	GS-200 / S / M / MS / Y / YS	GS-260 / S / M / MS / Y / YS	GS-280 / S / M / MS / Y / YS
47.4" (1,200 mm) ^{*1}	GS-200L / LS / LM / LMS / LY / LYS	GS-260L / LS / LM / LMS / LY / LYS	GS-280L / LS / LM / LMS / LY / LYS

L: Long Bed M: Live Tooling & C-axis S: Sub-spindle Y: Y-axis

^{*1} Turning length listed here are approximate numbers, individual models may vary. Please see Machine Specifications page for details.



(GS-280LM model shown with optional accessories)

- ▶ The built-in spindle type tailstock provides maximum rigidity and load capacity. The extension and retraction of the quill is programmable and thrust pressure adjustable.
- ▶ Available programmable base tailstock saves manpower and enables many critical applications to be performed efficiently. Positioning of the tailstock has been simplified through use of custom software interface. The Z-axis carriage automatically locks on to the base of the tailstock and drags it to the desired position.

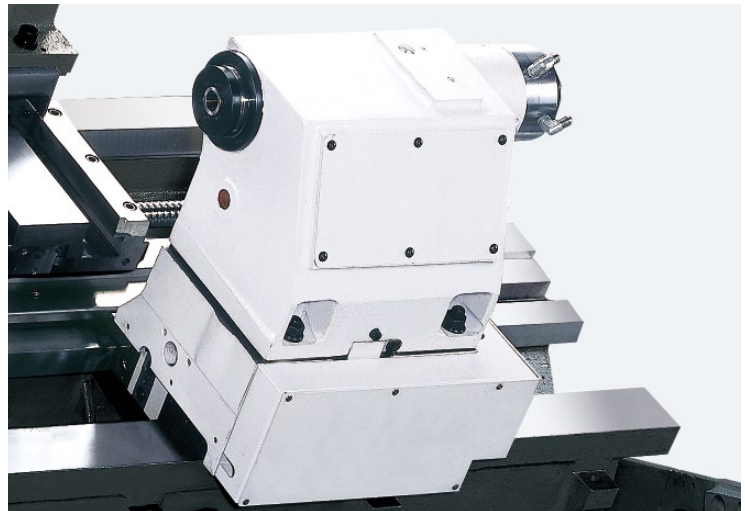

- ▶ Coolant system features a roll-out coolant tank for easy maintenance and high-pressure coolant pump for increased tooling cooling power.

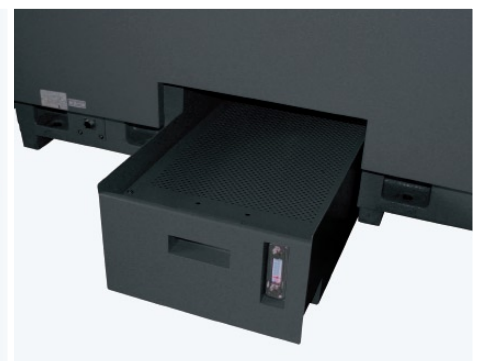

MAXIMUM STRENGTH CONSTRUCTION

- ▶ Major structural components have been combined into one solid platform. The low center of gravity 30° true slant bed design provides the most rigid foundation possible for the headstock, turret, and tailstock.
- ▶ By using Finite Element Methods (FEM), optimal reinforce ribbings are directly cast into the one-piece bed structure. Mechanical rigidity has been increased by more than 40% when compared to conventional designs. The GS-200 series is capable of performing super heavy-duty turning and maintain long-term super high-precision accuracy. More rigidity also means extended tool life.
- ▶ Built to endure years and years of rigorous high production turning, the heavily ribbed, one-piece thermally balanced bed and casting components are of FC35-Meehanite casting (industry standard is FC25~30). FC35 grade cast iron is capable of withstanding much greater stress without deforming and provides maximum vibration dampening, which result in a machine that will outlast and outperform the competition.

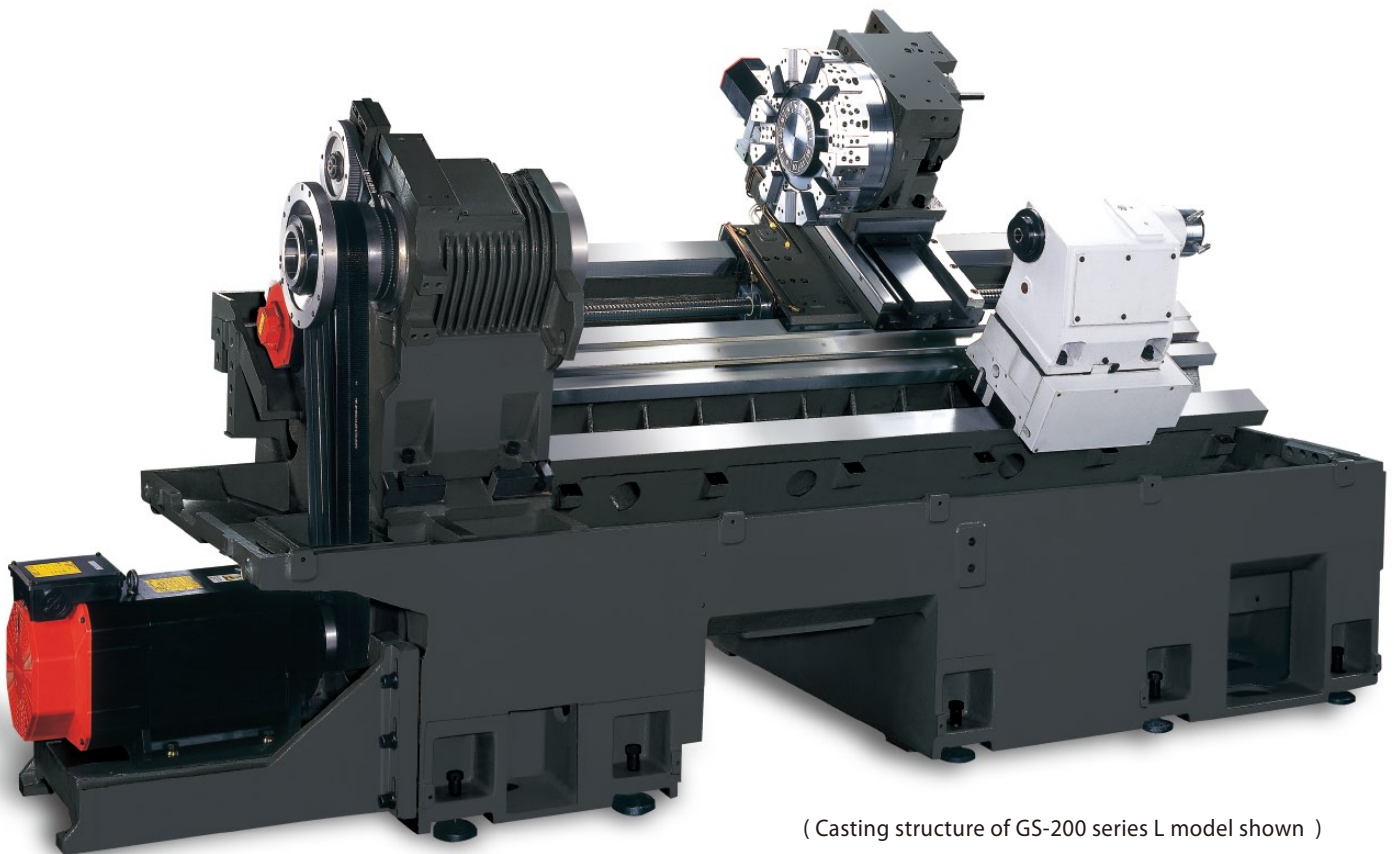

(Casting structure of GS-200 series L model shown)

- ▶ All spindle and servo motors, including drives, are Fanuc α *i* series components to ensure peak machining performance and accuracy.
- ▶ X and Z axes are driven by over-sized Fanuc α *i* series absolute AC servo motors, providing tremendous thrust outputs with faster acceleration and deceleration. Absolute encoder technology saves time and money by eliminating the use of limit switches, thus, eliminating referencing axes to home positions and replacing broken limit switches.

- ▶ C3 class hardened and precision ground ball screws ensure the highest accuracy and durability possible. Plus, pretension on all axes minimizes thermal distortion.

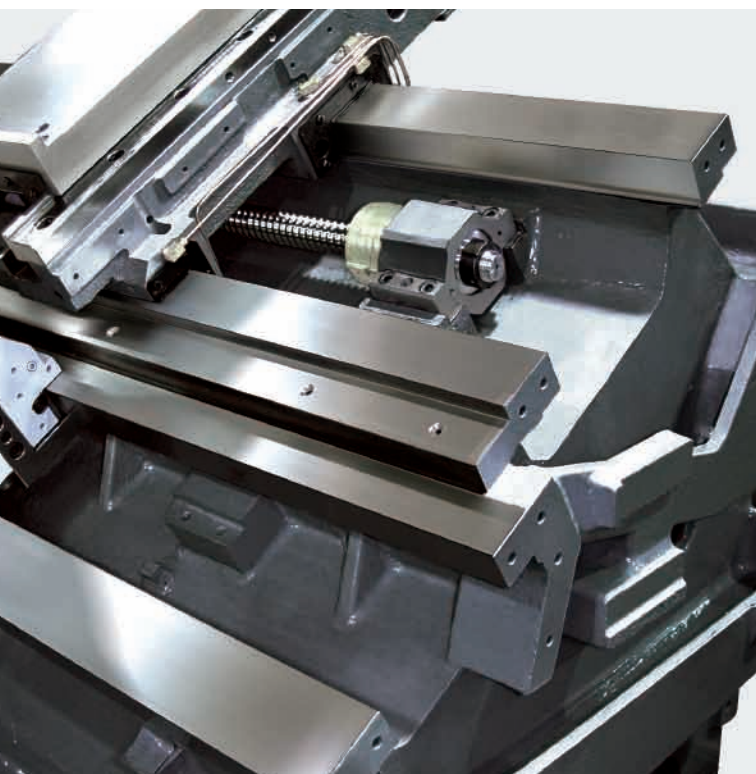

- ▶ Slide ways are bonded with "Turcite B" to eliminate stick-slip, minimize wear and maintain long term accuracy. Rapids are 20 m/min. (788 IPM) on X-axis & 24 m/min. (945 IPM) on Z-axis.
- ▶ Extra wide hardened and ground box ways are directly formed onto the machine bed and saddle during the casting process. They are precision machine and widely spaced for maximum strength. The box way design also provides the rigidity needed for heavy duty and interrupted turning applications.

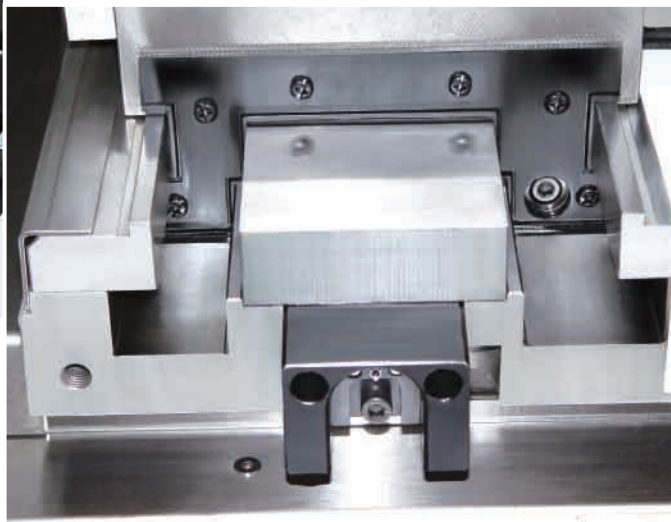

- ▶ Contact surfaces of all slides, headstock, turret, tailstock, and ball screw bearing housings with the machine bed are precision hand scraped to provide maximum assembly precision, structural rigidity, and load distribution.

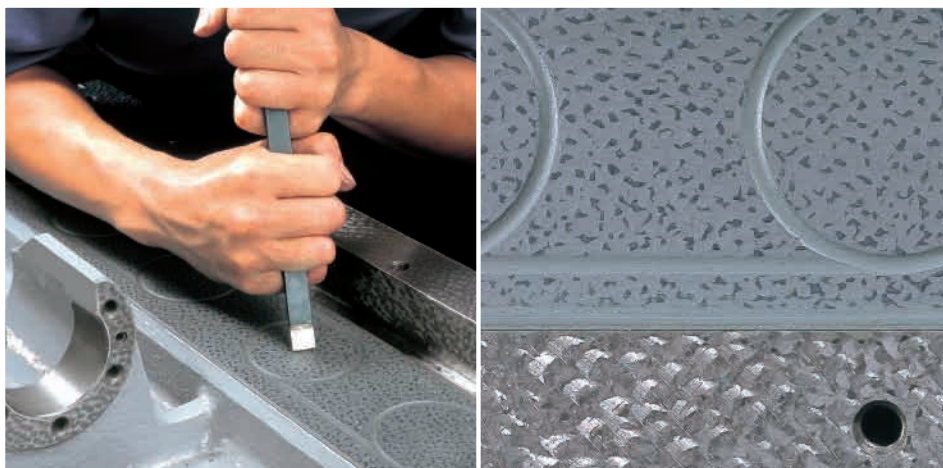

ULTIMATE TURNING POWER

- ▶ The heavy-duty headstock is of one-piece casting reinforced with heat dispending fins.
- ▶ P4 grade (Class 7) super-high precision bearings are directly assembled for maximum level of support and precision. Bearing configuration is designed for super heavy-duty cutting with ultra-smooth performance and long term durability with a higher level of accuracy.
- ▶ Standard rigid tapping feature provides high-speed precision tapping without the use of floating tap holders. Set-up is easier and depth of thread more accurate, permitting maximum productivity for tapping operations.
- ▶ Standard spindle orientation feature allows the spindle to stop at desired programmed position. Useful in broaching and manual part loading applications where a fixed spindle position is required.

【 Spindle Nose Dimension Drawing 】

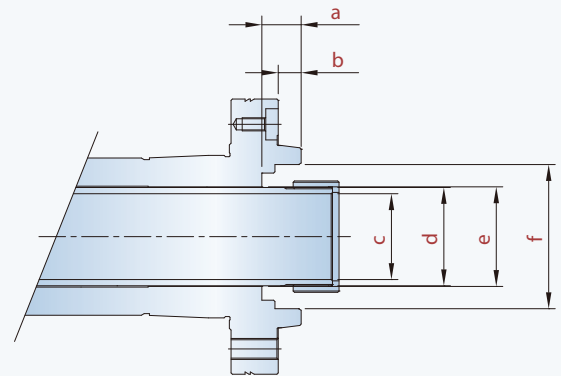

Model	a	b	c	d	e	f
GS-200/L	20	14.3	Ø52	Ø65	Ø66	Ø70
GS-260/L	30	17.5	Ø65.5	Ø75	Ø76	Ø110
GS-280/L	28.5	16	Ø75.5	Ø89.8	Ø90	Ø110

【 Spindle Dimension Drawing 】

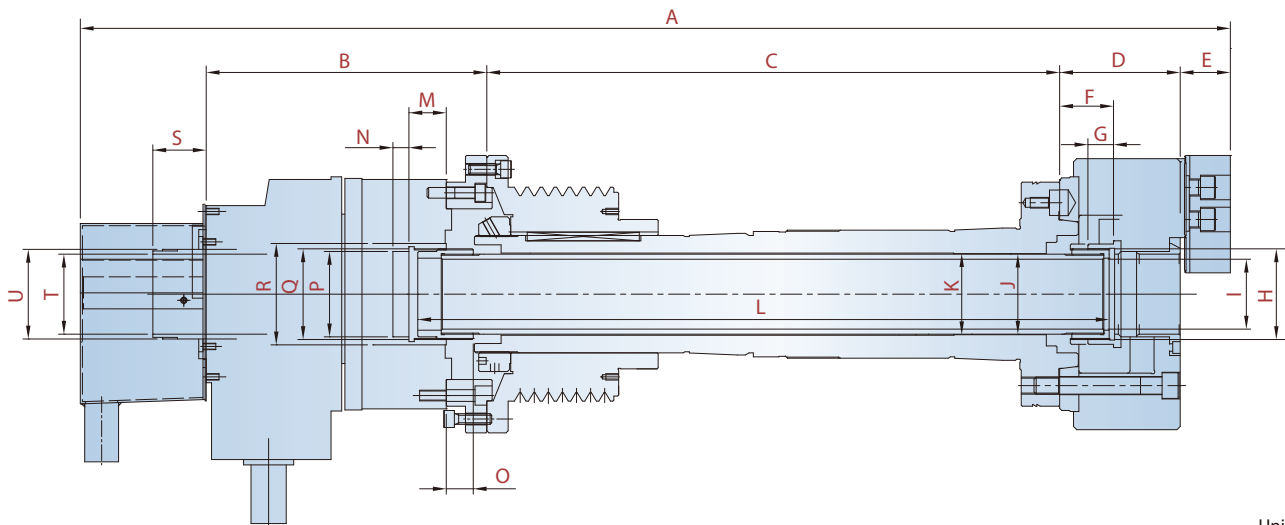

Unit : mm

Model	A	B	C	D	E	F	G	H	I	J	K
GS-200/L	944.2	214	505.1	103	42	max : 61.5 min : 45.5	17.5	M60xP2.0	52	65	66
GS-260/L	1051.5	263	510.5	113	46	max : 50.5 min : 34	24	M85xP2.0	65.5	75	76
GS-280/L	1123.6	302	557.5	122	54	max : 56 min : 33	30	M89xP2.0	75.5	89.8	90

Model	L	M	N	O	P	Q	R	S	T	U
GS-200/L	624	max : 30 min : 8	15	max : 22 min : 0	55	M60xP2.0	70	max : 47 min : 25	52	M58xP1.5
GS-260/L	643	max : 35 min : 10	15	max : 25 min : 0	80	M85xP2.0	95	max : 50 min : 25	75	M84xP2.0
GS-280/L	706	max : 35 min : 5	15	max : 30 min : 0	95	M100xP2.0	110	max : 55 min : 25	91	M99xP2.0

- ▶ The precision direct belt drive system provides greater spindle control, flexibility and serviceability. Pulley ratios fine tune the motor's maximum RPM to match the spindle's maximum RPM, which result in full output at the lowest RPM possible. Thus, utilizing the full potential of the spindle motor for maximum cutting power.

5
6

Standard / High-speed Spindle Output

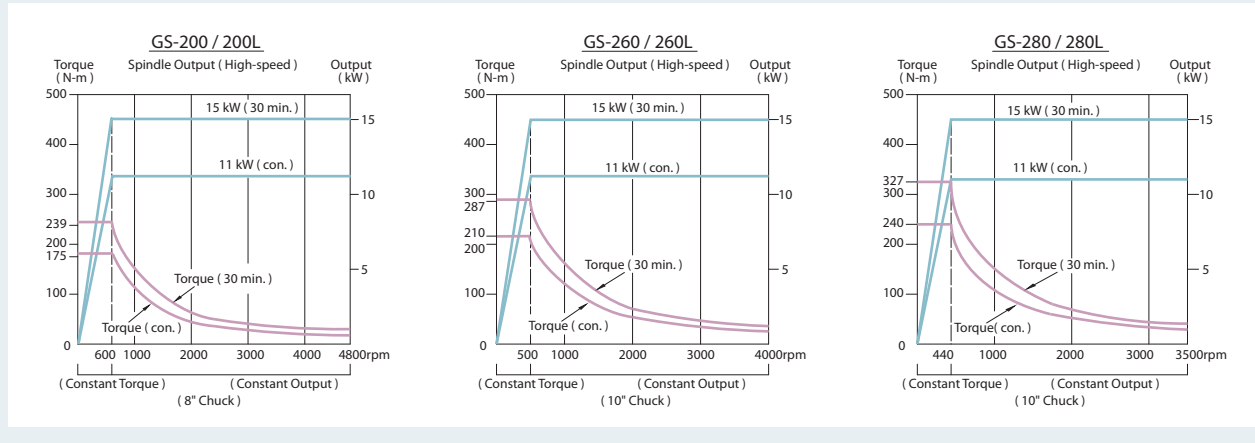

Low-speed Spindle Output

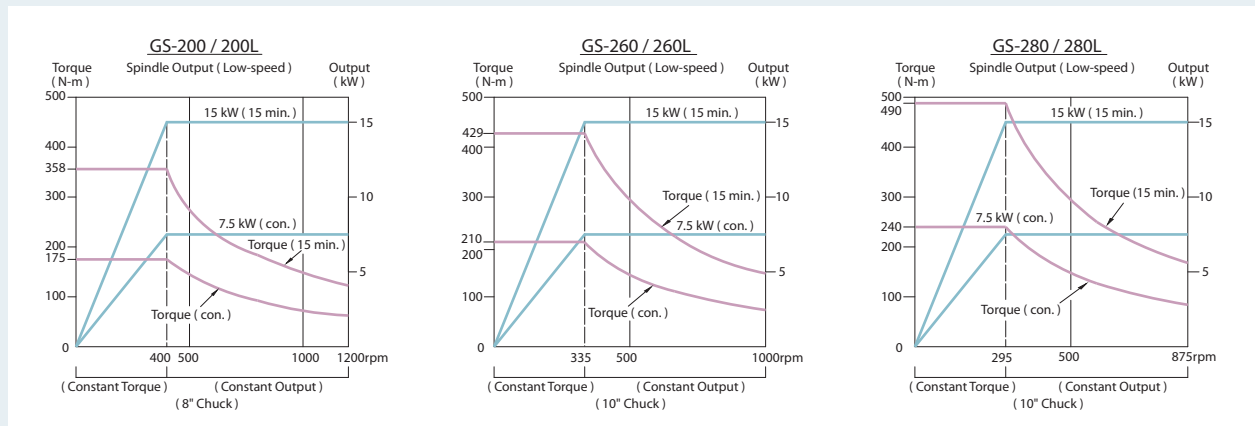

- ▶ Available 2-speed motor configuration further increases the spindle's cutting ability and flexibility. In low range, the motor reaches full output at 1/3 the RPM of standard motors, and torque output is approximately 3 times more. This system offers the advantages of a gear box without the noise, hassle of maintenance, slow gear change, and expensive rebuilds when a gear box wears out.

- ▶ Generating twice the torque output of standard motors, the A/C, constant output, wide-range Fanuc α P22 high-torque *i* series motor is rated at 15 kW (30 min). This double bind motor is designed to reach full output at 1/2 the RPM of standard motors, providing the ability to take heavier cuts in the lower RPM ranges.

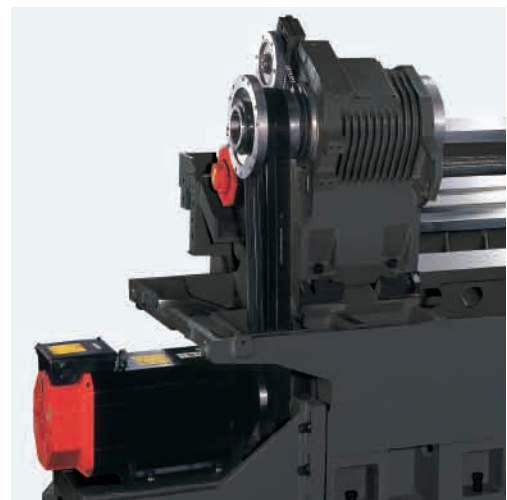

ADVANCED TURRET TECHNOLOGY

- ▶ The super heavy-duty servo indexing turret features the newest non-lifting turret disk technology. Achieving 0.2 second indexing times for adjacent stations and 0.5 second for stations at the opposite end of the disk. Index movements are single step, without pauses, no matter how many stations are skipped.
- ▶ 220 mm (8.66") diameter super high precision 3-piece curvic couplings accurately position the turret disk and 4,000 kg (8,800 lbs.) of clamping force ensures abundant turret rigidity for all cutting conditions.
- ▶ The standard 12-station turret clears 8" diameter work holding devices without interference, even when loaded with tooling at maximum shank size.

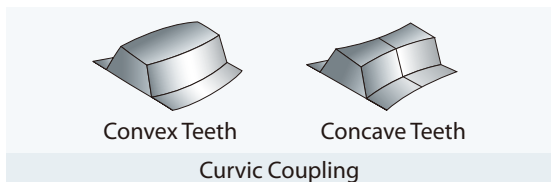

- ▶ The curvic couplings provide a large contact area and are designed with an auto-clean feature not seen on traditional couplings.

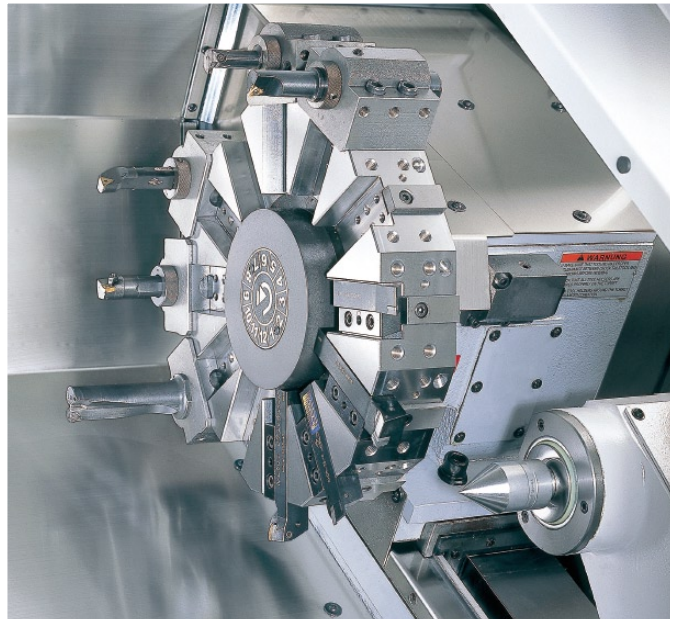

ULTIMATE C-AXIS SPINDLE

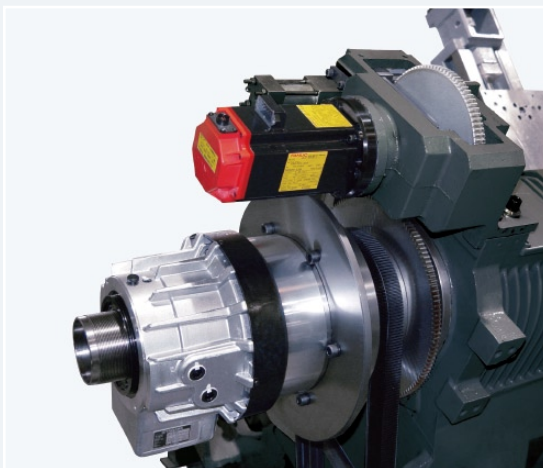

- ▶ The Cf-axis and disk brake system available on the GS-200 series provides the most rigid and powerful type of C-axis on the market today. In Cf-axis mode, a servo motor is engaged and drives the rotation of the spindle ; engagement time is approximately 1 second.
- ▶ Working with the live tooling turret, the Cf-axis and disk brake system enables the machine to perform multiple tasks, such as drilling, tapping, and milling operations, including cylindrical and polar coordinate interpolations (resembling a 4th-axis rotary table on a machining center).
- ▶ With the Fanuc servo motor generating an ultra high resolution of 120 million pulses per spindle rotation and 240 N-m (176 ft-lb.) of torque (Con.), machined surface finishes are much superior than Cs-axis (driven by spindle motor) equipped machines. Plus, dynamic accuracy is within $\pm 0.02^\circ$ even under heavy cutting loads.

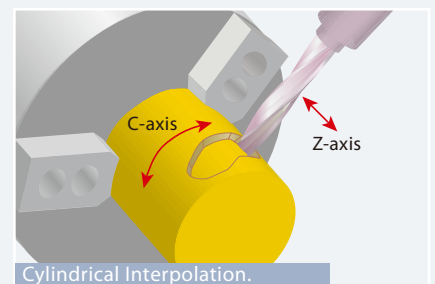
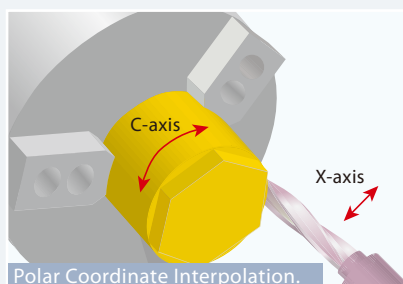
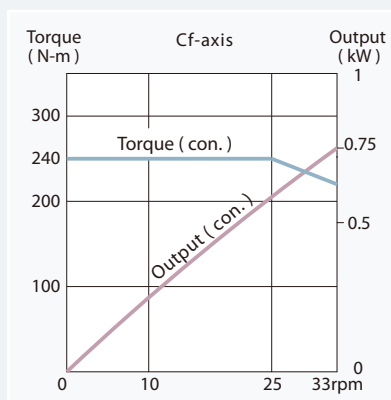

[CZ-type Turret]

Work Range

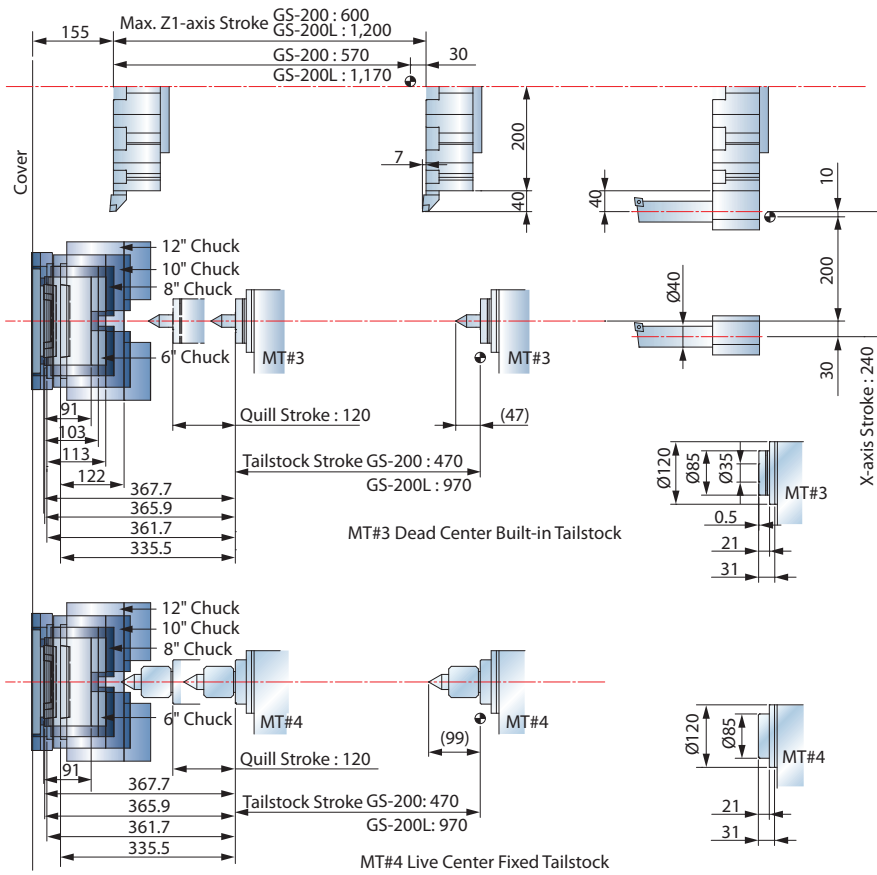

Tooling System

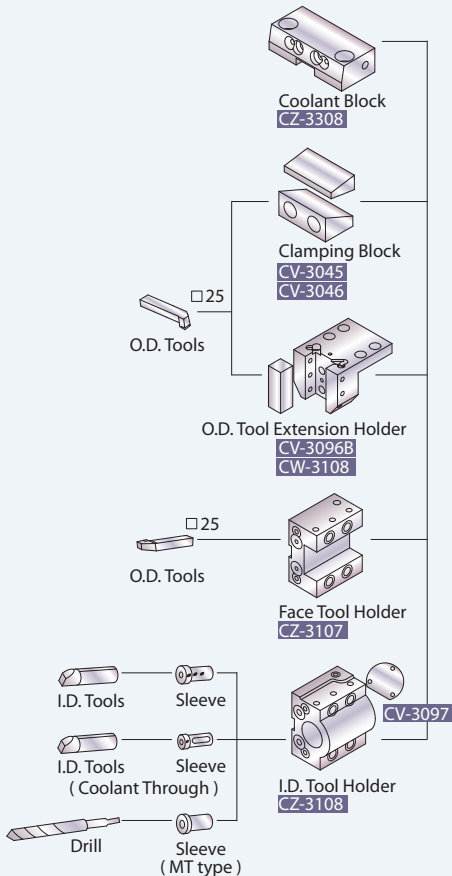

Interference Diagram

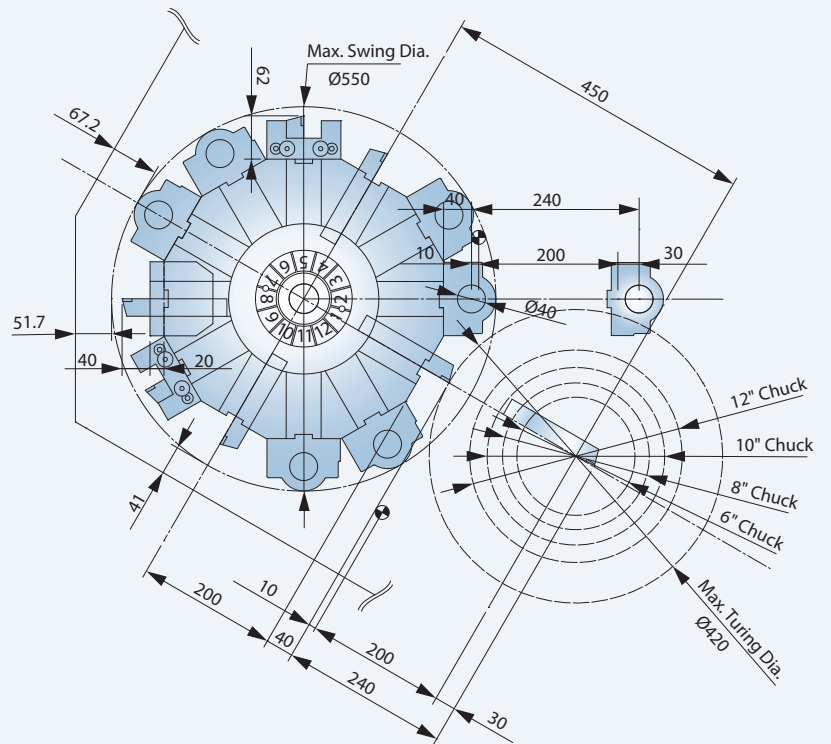

POWERFUL LIVE TOOLING TURRETS

- ▶ Live tooling and C-axis control capabilities on the GS-200 series allows the machine to perform multiple tasks on a work piece, such as turning, milling, drilling and tapping. This eliminates manpower and cycle time, while reducing accuracy lost, which will occur if the part is moved from machine to machine.

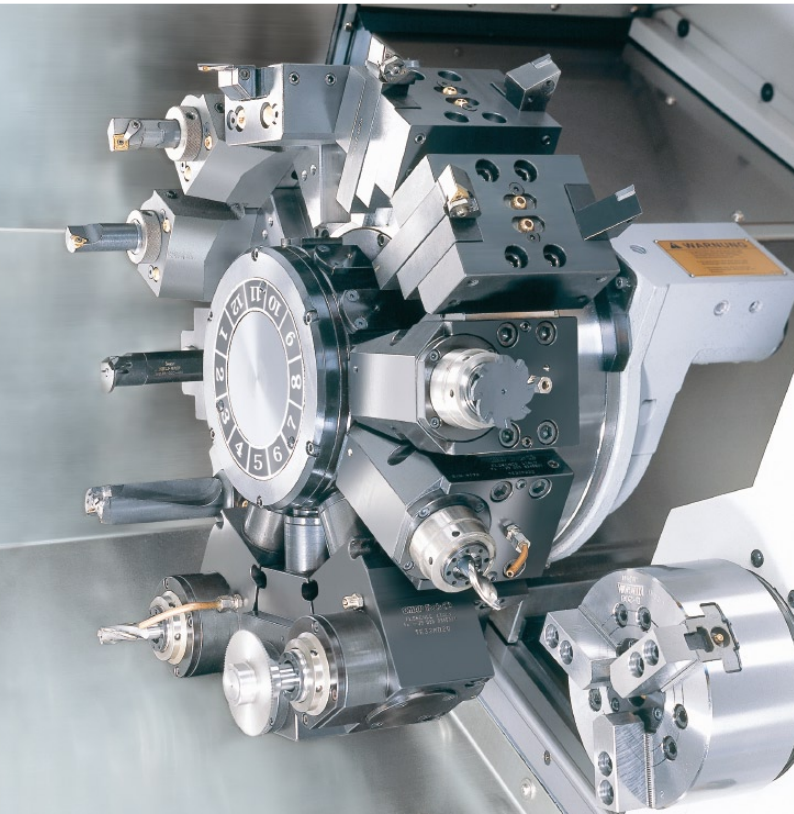

(Live tooling turret & sub-spindle shown)

- ▶ The 12-station Goodway live tooling turret offers 12 stations available for live tooling (live tooling tools rotate in working position only) and features a non-lifting turret disk.

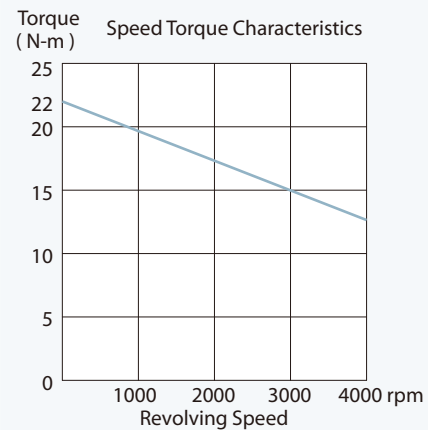

- ▶ Goodway's live tooling turret utilizes advance servo indexing technology to achieve 0.2 second indexing times for adjacent stations and 0.5 second for stations at the opposite end of the disk.
- ▶ With the latest technology, live tooling is driven by an AC servo motor to provide ample power, in the form of torque. Now, even the toughest of jobs may be tackled without a sweat.

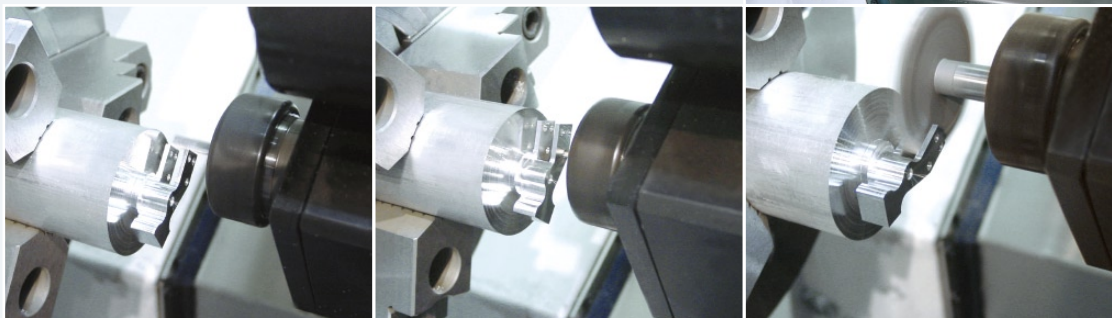
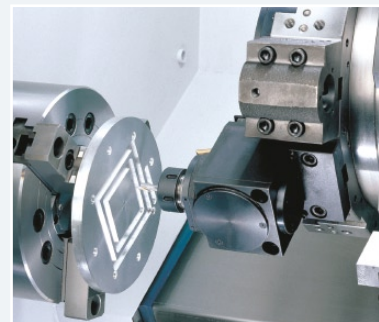

[Optional 12-Stations Live Tooling Turret]

Work Range

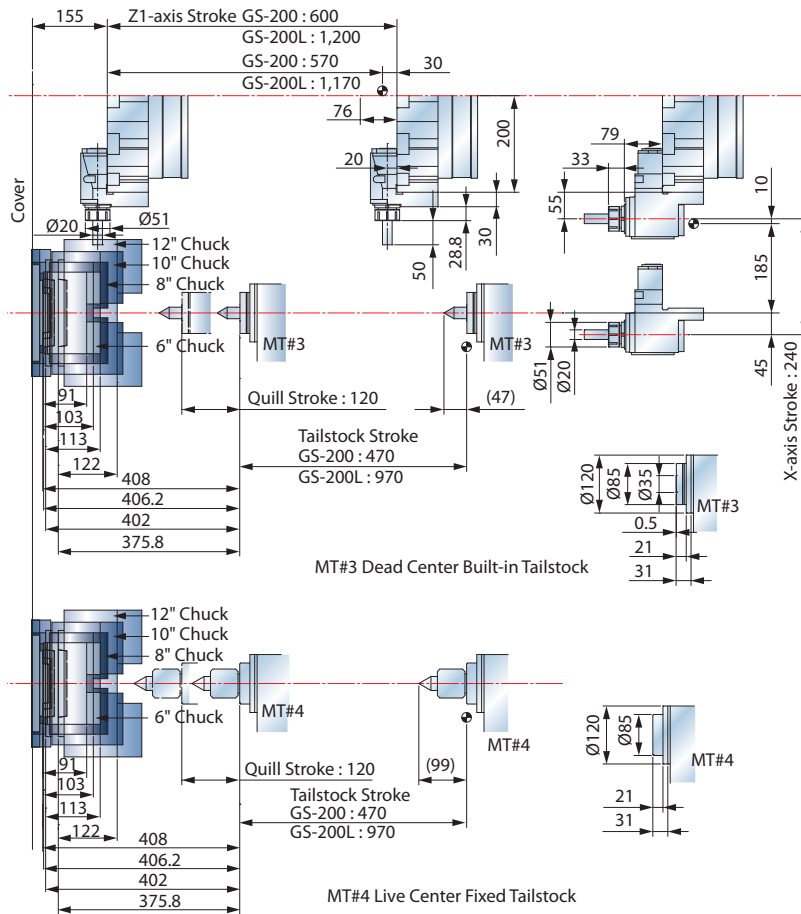

Tooling System

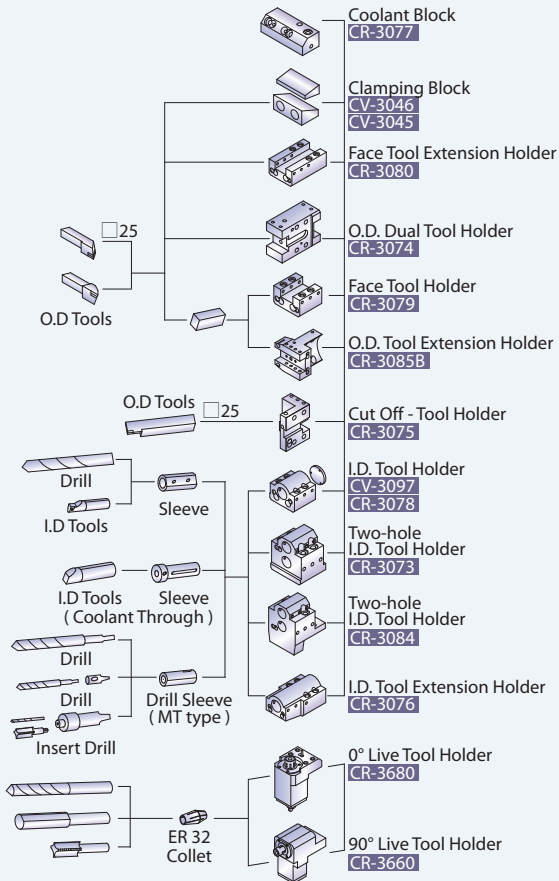

Interference Diagram

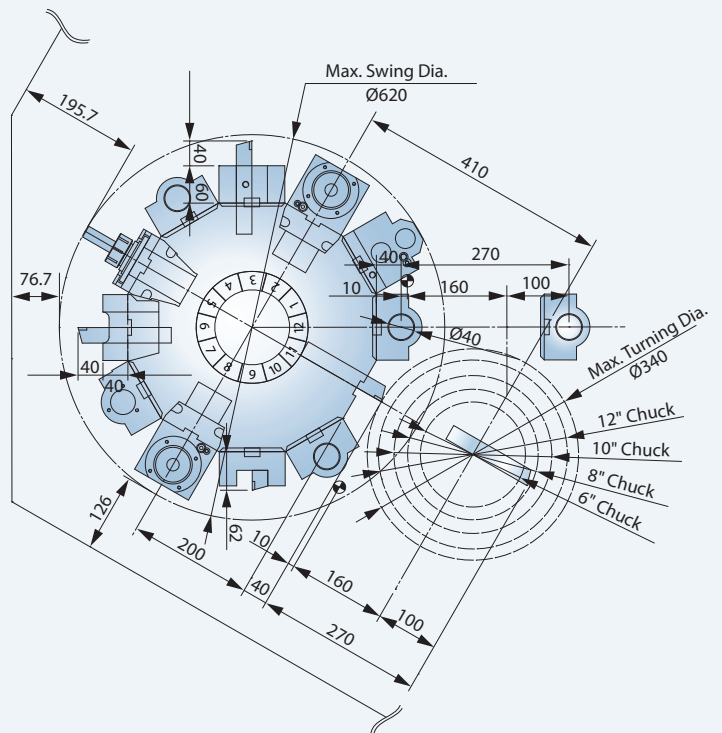

BACK-END MACHINING CAPABILITY

- ▶ A 6" chuck size sub-spindle driven by a powerful 7.5 kW (10 HP, 30 min.) built-in type Fanuc motor (Integrated Motor) for back-end machining is available on the GS-200 series.
- ▶ The sub-spindle travels on the B-axis, which has extra wide hardened and ground box ways. The box ways are directly formed onto the machine bed during the casting process. They are precision machined and widely spaced for maximum strength.

Sub-spindle Output

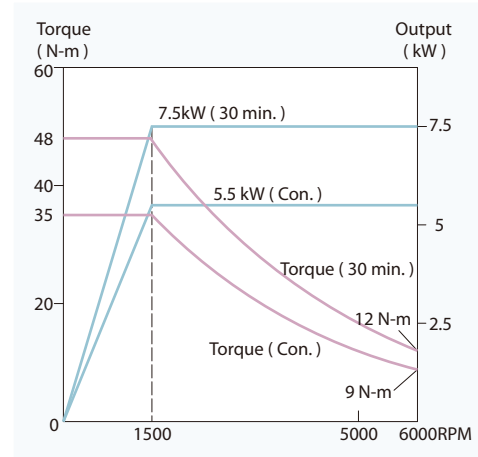

- ▶ Automatic part transfer of work piece from main spindle to sub-spindle saves manpower and cycle time, while reducing accuracy lost, which will occur if manually handling the part from machine to machine.

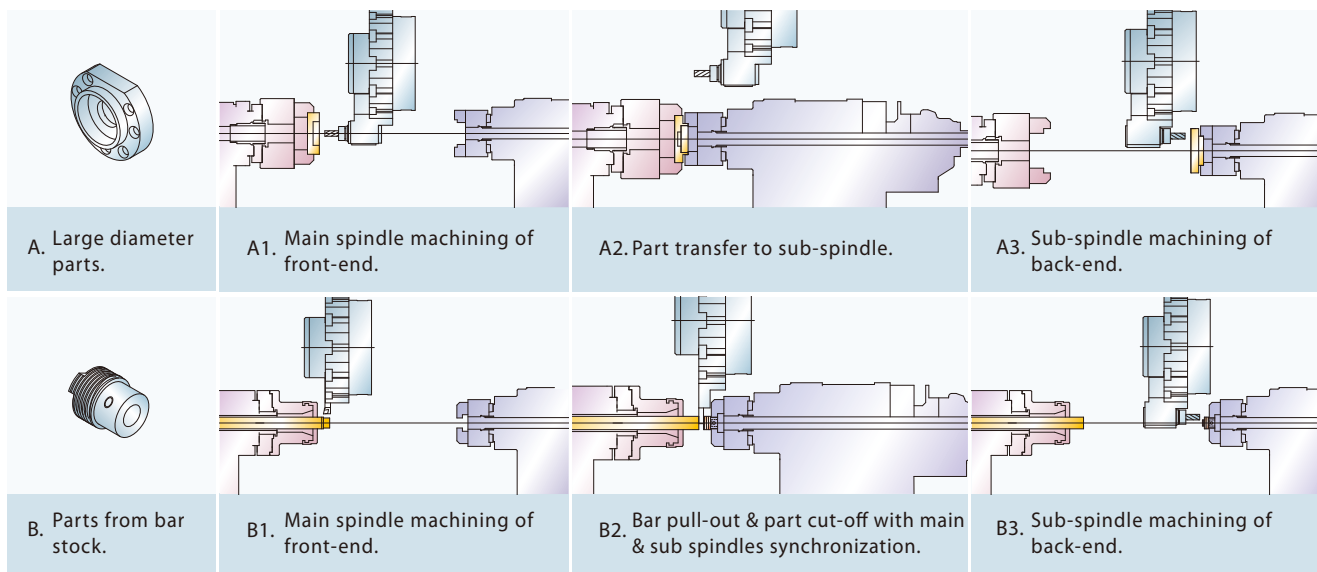

- ▶ With $\varnothing 38$ mm (1.50") bar capacity, the sub-spindle configuration is also ideal for machining long work pieces such as small diameter shafts. Both ends of the work piece can be supported by the main and sub spindles, allowing the middle section(s) to be accurately machined.

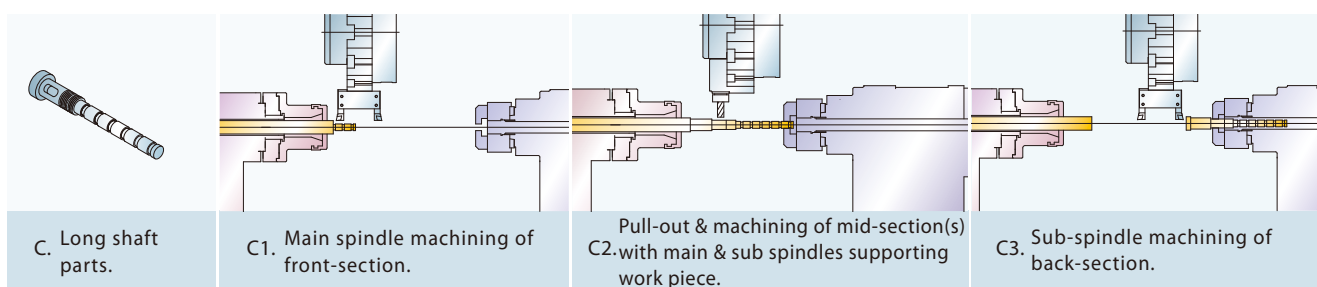

[Sub-spindle*1]

Work Range

(I.D. / O.D. Tooling)

11

12

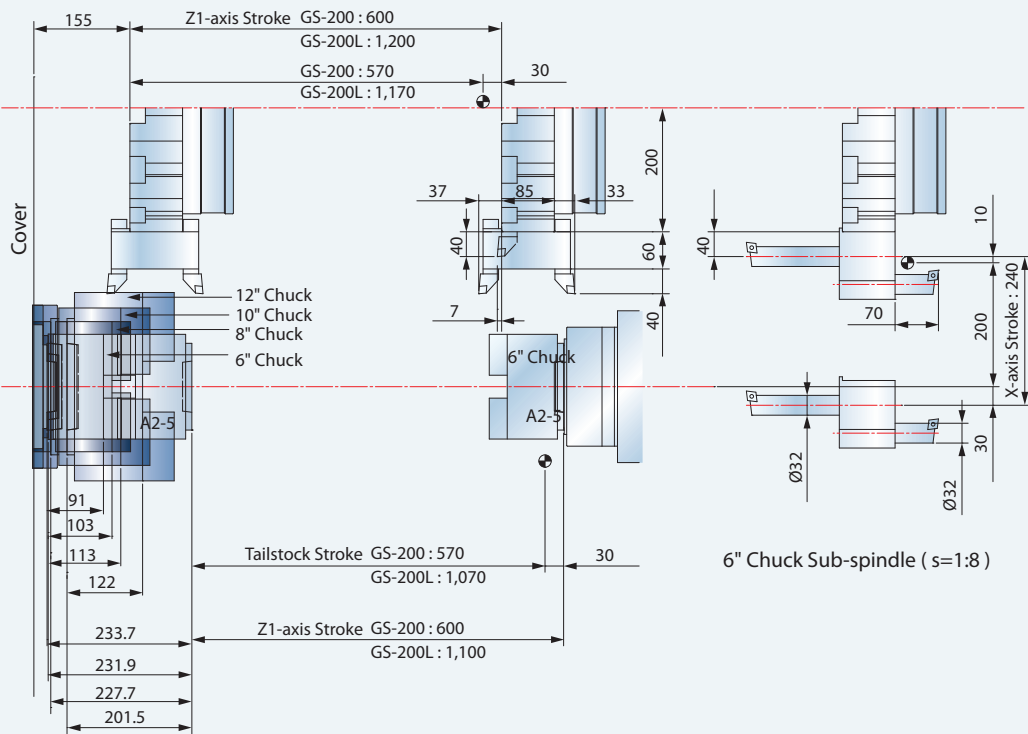

(Live Tooling)

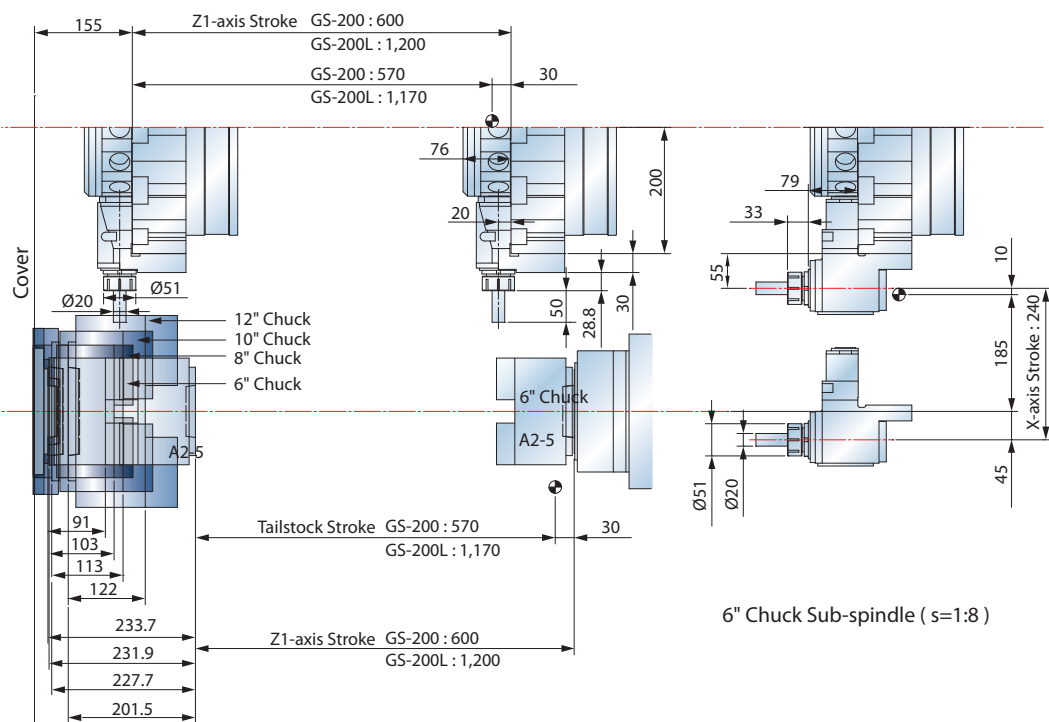

*1 For S model only, Tooling System & Interference diagram please see page 11 & 13.

Y-AXIS MACHINING CAPABILITY

- ▶ Y-axis control further enhances multi-tasking live tooling capabilities and improves various machining precision. High precision grooving and X-axis off-center drilling are enabled.
- ▶ With an abundant amount of Y-axis travel, 120 mm = + 65 mm / -55 mm (4.72" = + 2.56" / - 2.16"), a wide variety of parts may be efficiently machined.

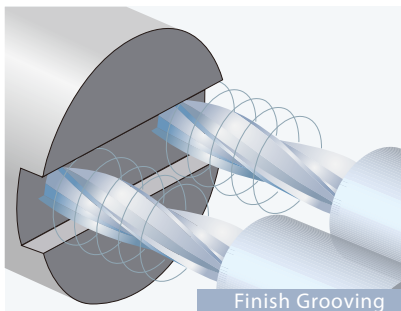
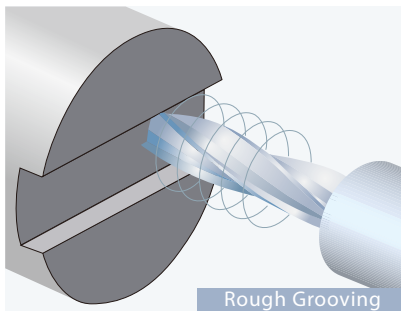
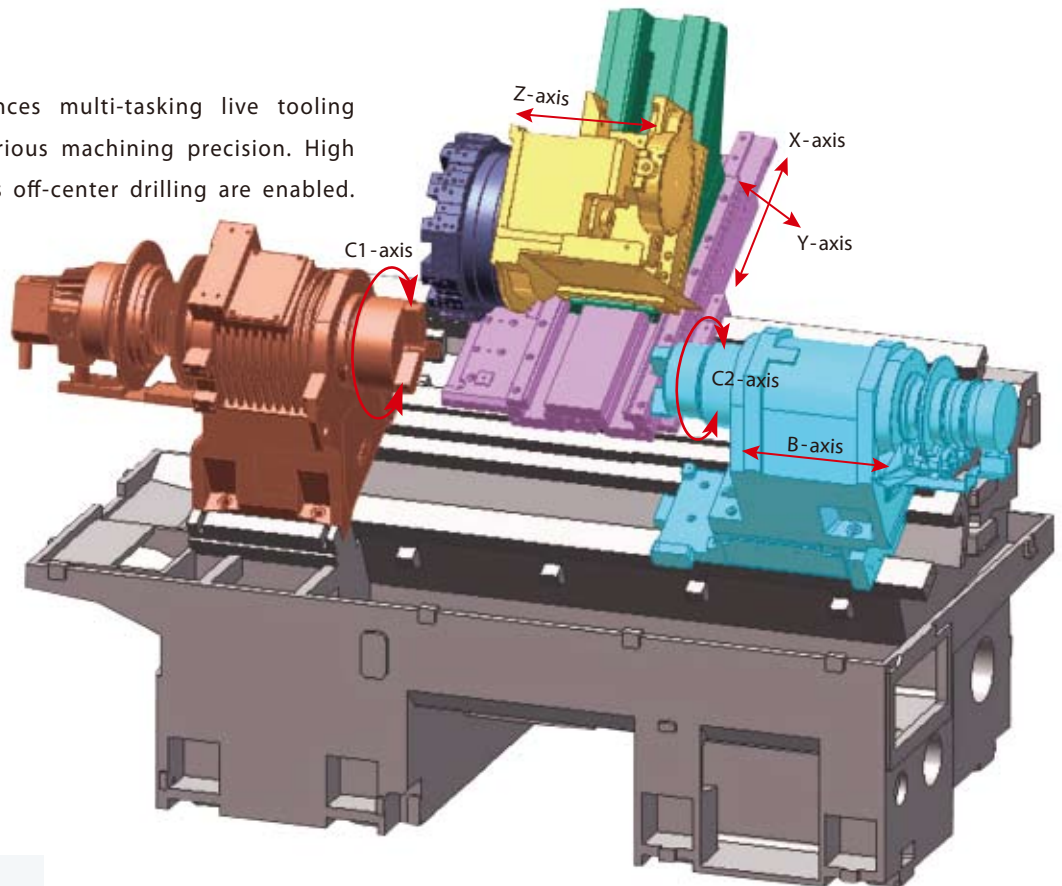

- ▶ On Y-axis equipped machines, the turret is mounted on a secondary 30 degrees wedge saddle on top of the X-axis slide. Both X & Y axes have extra wide hardened and ground box ways, which are directly formed onto the saddles during the casting process. They are precision machined and widely spaced for maximum strength.

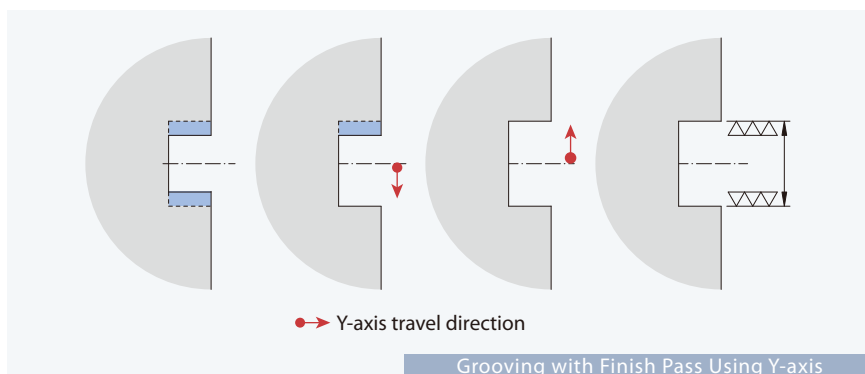
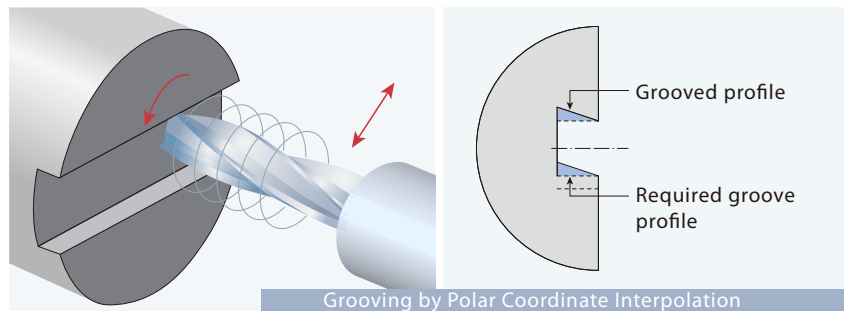

- ▶ Grooving with Y-axis control produces grooves with higher accuracy.

[Y-axis w/ Live Tooling Turret]

Tooling System

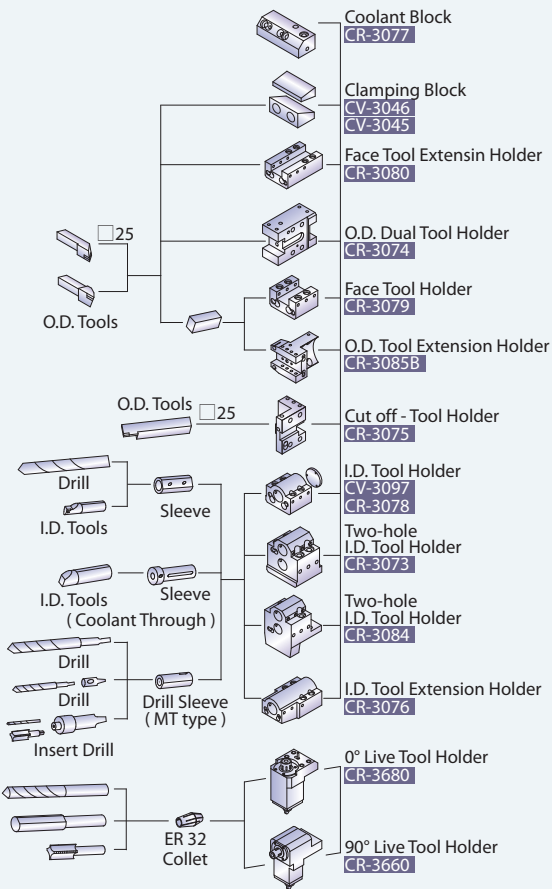

Inference Diagram

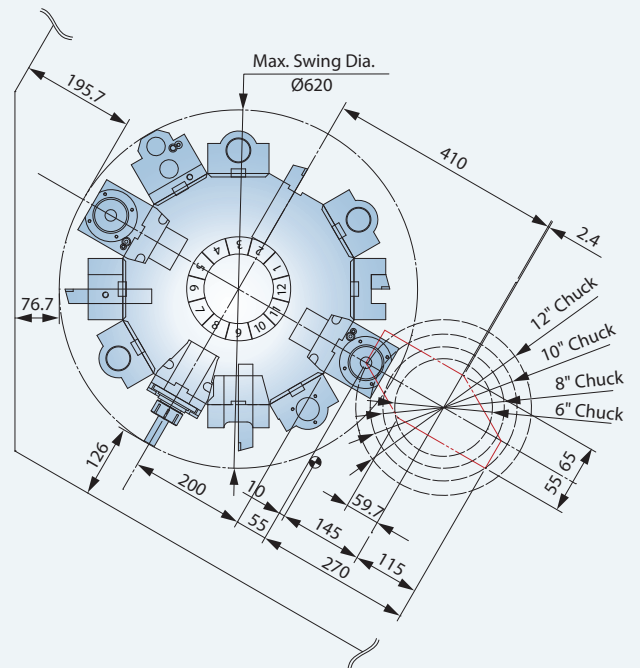
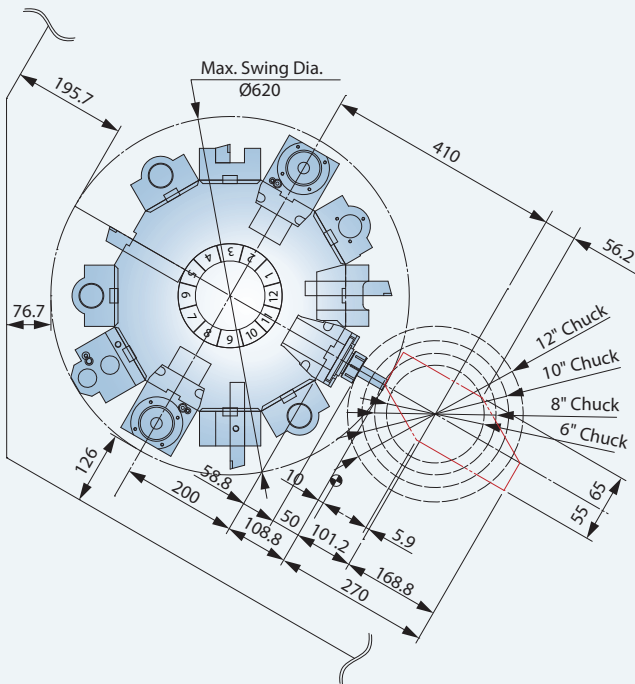
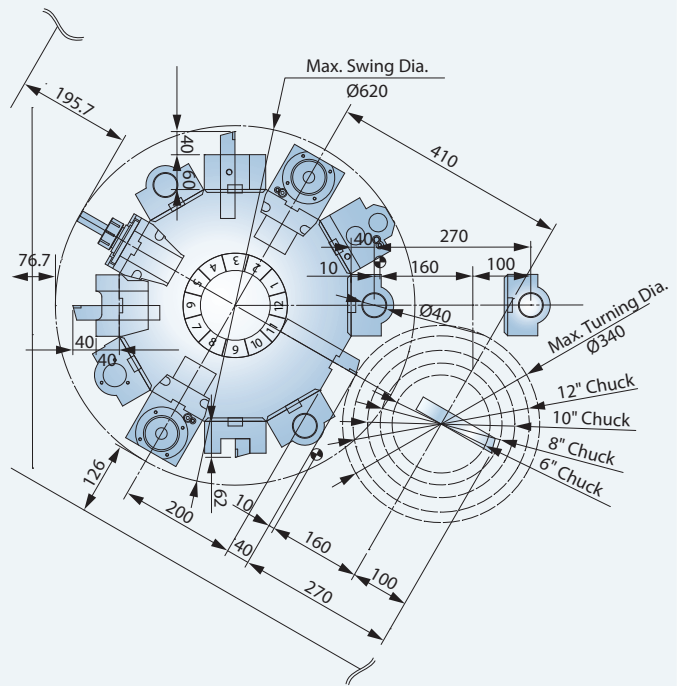

[Y-axis w/ Live Tooling Turret]

Work Range

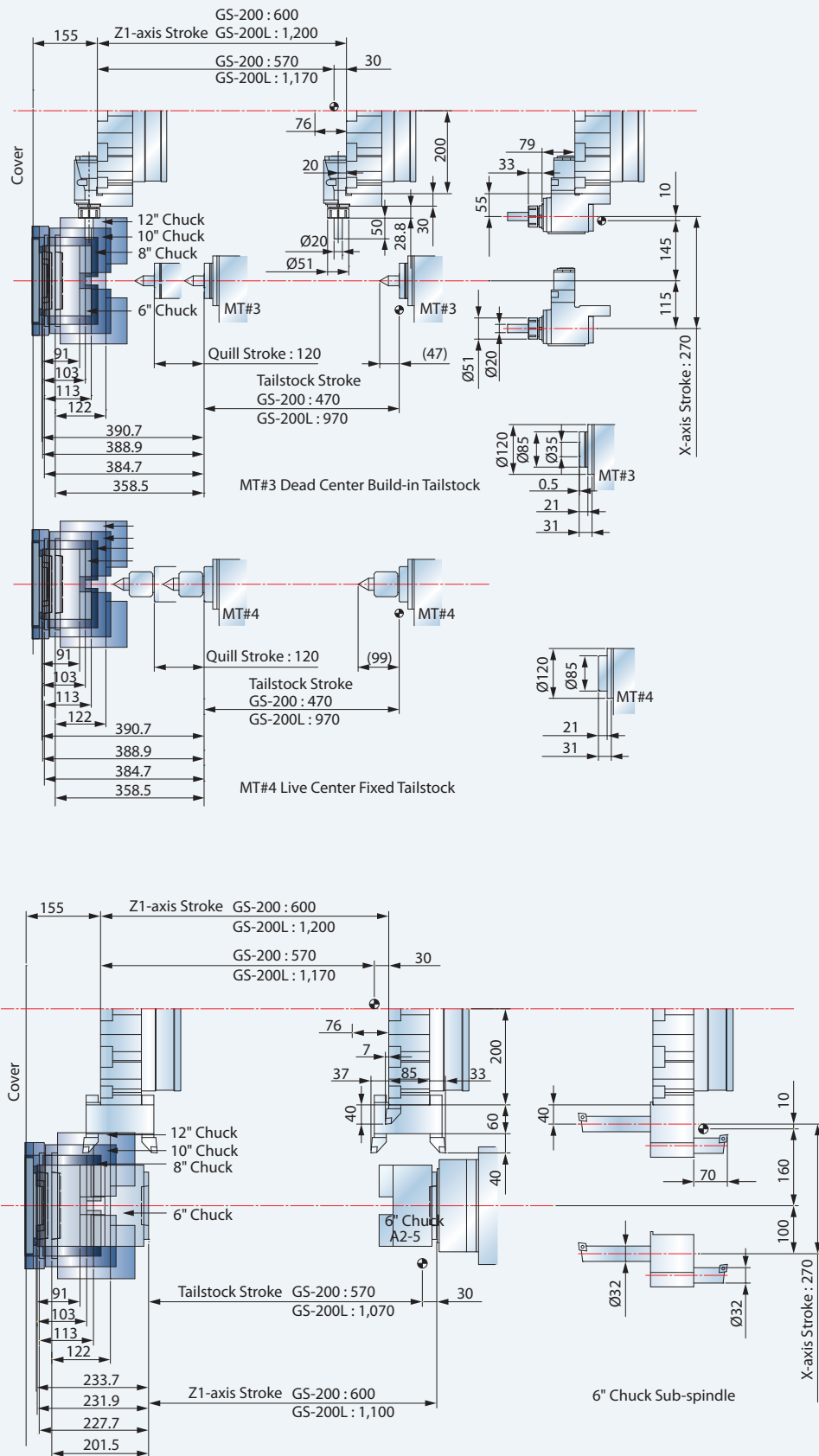

Unit : mm

Y-AXIS MACHINING CAPABILITY

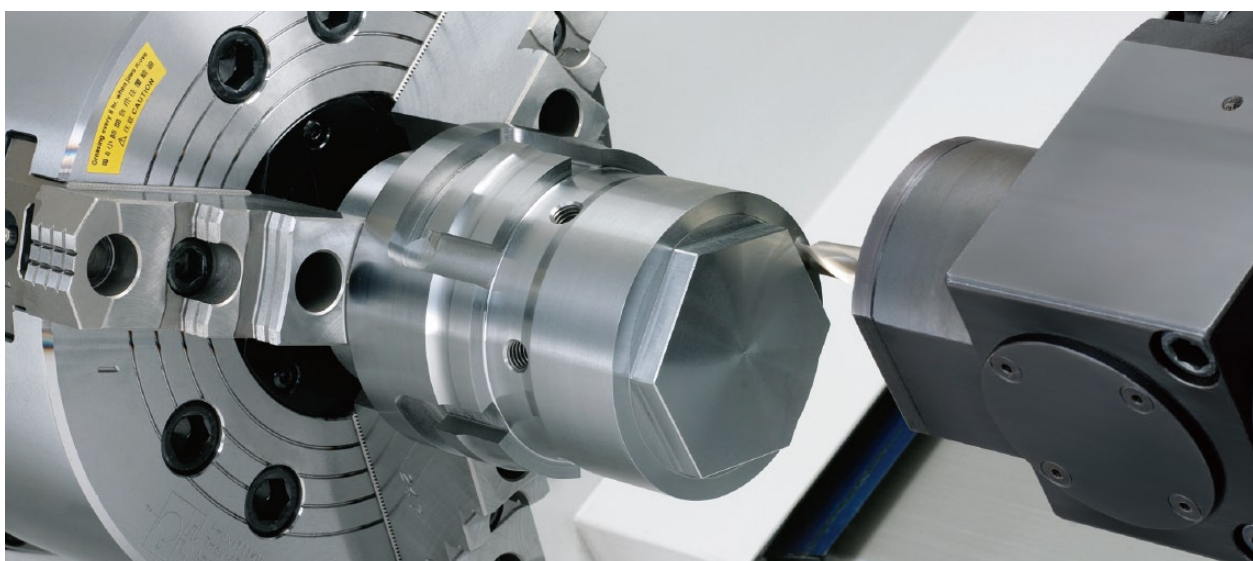

O.D. Heavy Cutting Example

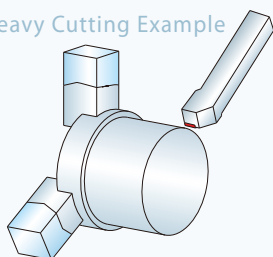

	O.D. Before Cut	O.D. After Cut	Spindle Speed	F/ Rev.	Depth of Cut	Spindle Load	Z-axis Load
1	108mm (4.25")	96mm (3.77")	500 RPM	0.30mm (0.00118")	6mm / side (0.2362" / side)	97%	56%
2	96mm (3.77")	82mm (3.22")	550 RPM	0.32mm (0.0125")	7mm / side (0.2755" / side)	112%	67%

Raw Material : S45C Model : GS-200M

I.D. Heavy Cutting Example

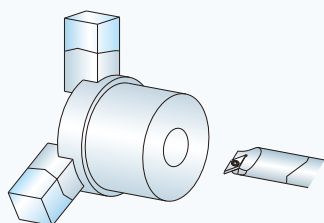

	I.D. Before Cut	I.D. After Cut	Spindle Speed	F/ Rev.	Depth of Cut	Spindle Load	Z-axis Load
1	74mm (2.91")	486mm (3.39")	850 RPM	0.30mm (0.00118")	6mm / side (0.2362" / side)	138%	52%
2	86mm (3.39")	94mm (3.70")	650 RPM	0.40mm (0.0157")	4mm / side (0.1575" / side)	97%	48%

Raw Material : S45C Model : GS-200M

	Tools (mm)	Spindle Speed (rpm)	Feedrate (mm/min)	Cutting Speed (m/min)	Cutting Depth (mm)
Drill	Ø16 HSS	350	35	10	N/A
End mill	Ø20 HSS end drill	400	80	25	10
Tapping	M16 * P2.0	200	400	10	N/A

Sample Work Pieces

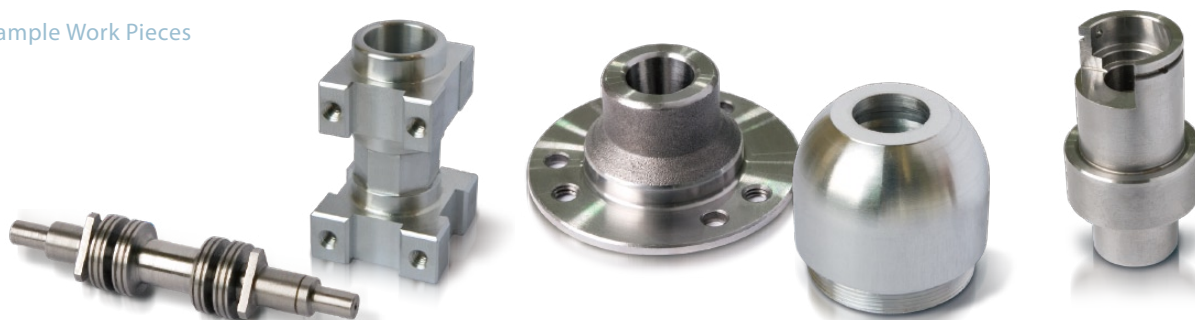

ENHANCED AUTOMATIONS

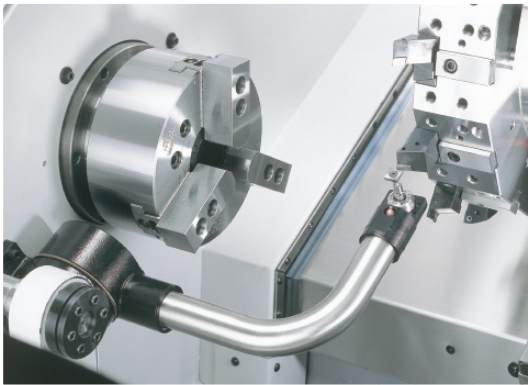

► The optional Renishaw HPMA tool presetter utilizes a motorized arm to lower the tool probe into position. An auto tool check function further increases tool touch-off efficiency.

► Hydraulic self-centering steady rests with Z-axis assist base and programmable clamping are available in various sizes.

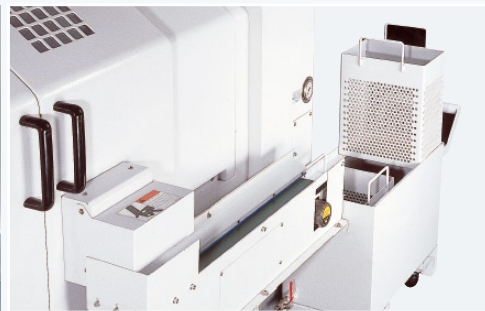
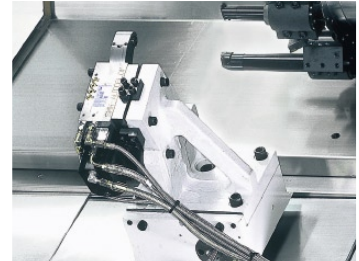

► Optional hydraulic parts catchers can be programmed to catch finished parts after cut-off. Part conveyor systems are also available.



► Optional bar feeders save manpower and provide greater productivity by automatically feeding bar stock into the machine after each part is completed. BF-65 bar feeding systems feed bars up to 65 mm (2.5") diameter and BF-80 systems feed bars up to 80 mm (3").

► Available standardized or custom gantry loading / unloading systems provide automatic operation for chucking operations. These flexible systems can be intergraded onto one or more machines to suit a wide range of applications.



STANDARD & OPTIONAL FEATURES

S: Standard O: Option
 -: Not Available C: Contact Goodway

		GS-200	GS-260	GS-280
SPINDLE				
Main spindle motor configuration	Single-speed	S	S	S
	Two-speed	O	O	O
Rigid tapping & spindle orientation		S	S	S
Disk brake for main or sub spindle		O	O	O
Cf-axis & disk brake for main spindle*1		O	O	O
Sub-spindle & 6" hydraulic cylinder*2		O	O	O
Cs-axis & disk brake for sub-spindle*1		O	O	O
WORK HOLDING				
Hydraulic hollow cylinder for chuck	8"	S	-	-
	10"	-	S	S
	10" Big-Bore	-	-	O
Hollow 3-jaws chuck & 1 set soft jaws	6"*2	O	O	O
	8"	O	-	-
	10"	-	O	O
	10" Big-Bore	-	-	O
Hard jaws		O	O	O
Collet chuck		O	O	O
Special work holding chuck		C	C	C
In spindle work stopper		O	O	O
Spindle liner (guide bushing)		O	O	O
Foot switch for chuck operation	Single	S	S	S
	Double	O	O	O
Programmable base & quill hydraulic tailstock		O	O	O
MT#3 dead center		O	O	O
Foot switch for tailstock operation	Single	O	O	O
	Double	O	O	O
Self-centering hydraulic steady rest		O	O	O
Foot switch for steady rest operation	Single	O	O	O
	Double	O	O	O
Two-stage programmable pressure	Chuck clamping	O	O	O
	Tailstock thrust	O	O	O
TURRET				
12-station turret w/ non-lifting tooling disk		S	S	S
12-station live tooling turret w/ non-lift tooling disk*1		O	O	O
Tool holder & sleeve package		S	S	S
Live tooling tool holders*1		O	O	O
MEASUREMENT				
Renishaw HPMA tool presetter	Motorized arm	O	O	O
COOLANT				
Coolant pump	3 Bar	S	S	S
	5 Bar	O	O	O
	10 Bar	O	O	O
High-pressure coolant system	20 Bar	C	C	C
Roll-out coolant tank		S	S	S
Oil skimmer		O	O	O
Coolant flow switch		O	O	O
Coolant level switch		O	O	O
Coolant intercooler system		O	O	O
CHIP DISPOSAL				
Chip conveyor with auto timer	Right discharge	S	S	S
	Rear discharge	C	C	C
Chip cart with coolant drain		O	O	O
Chuck air blow		O	O	O
Tailstock air blow		O	O	O
Coolant gun		O	O	O
Oil mist collector		O	O	O
AUTOMATIC OPERATION SUPPORT				
Parts catcher		O	O	O
Work piece transport conveyor		O	O	O
Bar feeder		O	O	O
Bar feeder interface		O	O	O
Gantry-type loader / unloader		O	O	O
Auto door		O	O	O
External M-code output	4 sets (8)	O	O	O
	8 sets (16)	O	O	O

Above standard & optional features also apply to L models.

*1 For M (live tooling turret) models only.

*2 For S (sub-spindle) models only.

*3 Standard with tailstock option.

*4 Fanuc 31*i* control option must be selected for M & S models.

*5 Please contact Goodway for complete control specification list.

*6 Alpha *i*P type spindle motors on all GS-200 series models.

		GS-200	GS-260	GS-280
SAFETY				
Fully enclosed guarding		S	S	S
Door interlock (incl. mechanical lock)		S	S	S
Impact resistant viewing window		S	S	S
Tailstock stroke out - end check*3		S	S	S
Chuck cylinder stroke out - end check		S	S	S
Chuck cylinder check valve		S	S	S
Low hydraulic pressure detection switch		S	S	S
Over travel (soft limit)		S	S	S
Load monitoring function		O	O	O
OTHERS				
Tri-color operation status signal light tower		S	S	S
Florescent work light		S	S	S
Electrical cabinet	Heat exchanger	S	S	S
	A/C cooling system	O	O	O
Complete hydraulic system		S	S	S
Hydraulic oil intercooler system		O	O	O
Advanced auto lubrication system		S	S	S
Foundation leveling & maintenance tool kit		S	S	S
Emergency maintenance electrical part package		S	S	S
Operation & maintenance manuals		S	S	S
CONTROL				
Fanuc Oi- TD control		S	S	S
Fanuc 31 <i>i</i> control*4		O	O	O

		Oi-TD	31 <i>i</i>
FANUC CONTROL FUNCTIONS*5			
PMC system	OiD PMC 0.025 μ sec/step	S	-
	31 <i>i</i> PMC 25 μ nsec/step	-	S
Display	8.4" color LCD	S	-
	10.4" color LCD	O	S
Graphic function	Standard	S	S
	Dynamic	O	O
Full keypad	Small - 44 keys	S	-
	Large - 56 keys	O	S
Part program storage length	512K byte	S	-
	1M byte	-	S
	2M byte	-	O
	4M byte	-	O
Registerable programs	8Mbyte	-	O
	400	S	-
	1,000	-	S
	4,000	-	O
Tool offset pairs	64	S	-
	99	O	S
	400	-	O
	499	-	O
	999	-	O
	2000	-	O
Servo control	HRV2 (3)	S	S
Conversational programming	Manual Guide Oi	S	-
	Manual Guide <i>i</i>	O	S
Servo motors	α <i>i</i>	S	S
Spindle motors	α <i>i</i>	S	S
Tool Life Management		S	S
Tool Nose Radius Compensation		S	S
Background editing		S	O
Variable Lead Thread Cutting		S	S
Polygon Turning		S	S
Unexpected disturbance torque detection function		S	S
Polar coordinate & cylindrical interpolation		-	O
Multiple Threading		S	S
Run hour & parts counter		S	S
Auto power off function		S	S
Custom macro B		S	S
RS-232 port		S	S
Memory card input /output		S	S
Ethernet		S	S
Fast ethernet		O	O

MACHINE SPECIFICATIONS 1

CAPACITY	GS-200 / 200L	GS-260 / 260L	GS-280 / 280L	
Max. swing diameter		Ø 670 mm (26.37")		
Swing over saddle		Ø 500 mm (19.68")		
Max. turning diameter*1		Ø 400 mm (15.75")		
Standard turning diameter*1		Ø 205 mm (8.07")		
Max. turning length*1	591 mm / 1,191 mm (23.27") / (46.89")	560 mm / 1,160 mm (22.05" / 45.67")	534 mm / 1,134 mm (21.02") / (44.65")	
Max. weight load*2	170 Kg (374 lbs.)	230 Kg (506 lbs.)	250 Kg (550 lbs.)	
Chuck size*3	Ø 8"	Ø 10"	10"*4	
Bar capacity	Ø 51 mm (2.00")	Ø 65 mm (2.55")	Ø 75 mm (2.95")*4	
SPINDLE				
Hole through draw tube	Ø 52 mm (2.05")	Ø 66 mm (2.59")	Ø 75.5 mm (2.97")	
Hole through spindle	Ø 66 mm (2.59")	Ø 76 mm (2.99")	Ø 90 mm (3.54")	
Spindle bearing diameter	Ø 100 mm (3.93")	Ø 120 mm (4.72")	Ø 130 mm (5.11")	
Hydraulic cylinder	8"	10"	10"*4	
Spindle nose	A2-6	A2-8	A2-8	
Spindle motor type	Fanuc α P22 / 6,000 i (AC / Wide-Range / Con. Ouptut)			
Motor output (Con.)	11 kW (15 HP)			
Motor output (30 min.)	15 kW (20 HP)			
Motor full output speed	750 rpm			
Spindle drive system	Direct Belt Drive			
Spindle drive ratio	4 : 5	2 : 3	7 : 12	
Spindle speed range	48 ~ 4,800 rpm	40 ~ 4,000 rpm	35 ~ 3,500 rpm	
Spindle full output speed	600 rpm	500 rpm	440 rpm	
Spindle torque (Con.)	175 N-m (129 ft-lbs)	210 N-m (155 ft-lbs)	239 N-m (176 ft-lbs)	
Spindle torque (30 min.)	239 N-m (176 ft-lbs)	287 N-m (212 ft-lbs)	327 N-m (241 ft-lbs)	
2-SPEED SPINDLE (OPTIONAL)				
Spindle speed ranges	L	48 ~ 1,200 rpm	40 ~ 1,000 rpm	35 ~ 875 rpm
	H	1,201 ~ 4,800 rpm	1,001 ~ 4,000 rpm	876 ~ 3,500 rpm
Spindle full output speed	L	400 rpm	335 rpm	295 rpm
	H	600 rpm	500 rpm	440 rpm
Spindle torque (15 min.)	L	358 N-m (264 ft-lbs)	429 N-m (317 ft-lbs)	490 N-m (362 ft-lbs)
Spindle torque (30 min.)	H	239 N-m (176 ft-lbs)	287 N-m (212 ft-lbs)	327 N-m (242 ft-lbs)
Cf-AXIS SPINDLE (OPTIONAL)				
Cf-axis drive motor	AC 0.75 kW (1HP Fanuc α 2 / 5,000i, Absolute encoder, 1,000,000 / rev.)			
Cf-axis drive ratio	1 : 120			
Cf-axis rapid	33 rpm			
Cf-axis torque output (Con.)	240 N-m (177 ft-lbs)			
Min. spindle indexing angle	± 0.001°			
Dynamic accuracy	± 0.002°			

Specifications are subject to change without notice.

*1 Individual models may vary, please see interference drawings.

*2 Work piece supported by chuck & tailstock.

*3 Chucks optional.

*4 Optional 10" Big-bore hydraulic cylinder & chuck provide Ø 78 mm (3.07") bar capacity.

X & Z AXES	GS-200 / 200L	GS-260 / 260L	GS-280 / 280L
Max. X-axis travel*1	+10 mm, - 190 mm, - 40 mm (0.39", - 7.48" , -1.57")		
Max. Z-axis travel*1	+ 30 mm, - 570 mm (+ 1.18" , - 22.44") / + 30mm, - 1,170 mm (+ 1.18" , - 46.06")		
X / Z axes rapids	20 m/min. (788 IPM) / 24 m/min. (945 IPM)		
Slide way type	Hardened & Ground Box Ways		
Feed rates	1 ~ 4,800 mm/min. (1 ~ 189 IPM)		
X-axis servo motor	AC 1.6 kW (2.2 HP, Fanuc α 8 / 3,000 <i>i</i> , Absolute encoder, 1,000,000 / rev.)		
Z-axis servo motor	AC 3.0 kW (4.1 HP, Fanuc α 12 / 3,000 <i>i</i> , Absolute encoder, 1,000,000 / rev.)		
X-axis ball screw \varnothing / pitch	\varnothing 32 mm (1.26") / Pitch 6		
Z-axis ball screw \varnothing / pitch	\varnothing 36 mm (1.41") / Pitch 10		
X / Z axes thrust (Con.)	855 Kgf (1,884 lbs.) / 769.4 Kgf (1,692 lbs)		
TURRET			
Stations	12		
Indexing drive	Fanuc AC Servo motor		
Indexing speed	0.2 sec. Adjacent / 0.5 sec. 180 degrees (Single step)		
Accuracy	Positioning: \pm 0.00069°, Repeatability: \pm 0.00027°		
OD tool shank size	<input type="checkbox"/> 25 mm (Inch version : <input type="checkbox"/> 1")		
ID tool shank size	Up to \varnothing 40 mm (Inch version : \varnothing 1-1/2")		
LIVE TOOLING TURRET (OPTIONAL)			
Max. turning length*1	600 mm (23.62") / 1,200 mm (47.24")		
Stations	12		
Live tooling stations	12 (Live tooling tools rotate in working position only.)		
Live tooling drive motor	AC 4.5 kW (6 HP, Fanuc α 22 / 4,000 <i>is</i> , Absolute encoder, 1,000,000 / rev.)		
Live tooling torque	22 N-m (16 ft-lbs.) [Con.]		
Indexing drive type	Fanuc AC Servo motor		
Index speed	0.2 sec. Adjacent / 0.5 sec. 180 degrees (Single step)		
OD tool shank size	<input type="checkbox"/> 25 mm (Inch version : <input type="checkbox"/> 1")		
ID tool shank size	Up to \varnothing 40 mm (Inch version : \varnothing 1-1/2")		
Live tooling shank size	1 ~ 20 mm (0.04" ~ 0.78") ER 32 collets		
Live tooling RPM range	10 ~ 4,000 rpm		
Y-AXIS (OPTIONAL)			
Max. turning diameter	\varnothing 340 mm (13.38")		
Max. X-axis travel*1	+ 10 mm, - 160 mm, - 100 mm (+ 0.39", -6.29", -3.93")		
Max. Y-axis travel*1	110 mm \pm 55 mm (4.33" \pm 2.17")		
X / Y axes rapids	20 m/min. (787 IPM) / 10 m/min. (393 IPM)		
Slide way type	Hardened & Ground Box Ways		
Feed rates	1 ~ 4,800 mm/min. (1 ~ 189 IPM)		
X-axis servo motor	AC 2.7 kW (3.6 HP, Fanuc α 12/4,000 <i>is</i> , Absolute encoder, 1,000,000 / rev.)		
Y-axis servo motor	AC 1.6 kW (2.2 HP, Fanuc α 8/3,000 <i>i</i> , Absolute encoder, 1,000,000 / rev.)		
X-axis ball screw \varnothing / pitch	\varnothing 36 mm (1.41") / Pitch 8		
Y-axis ball screw \varnothing / pitch	\varnothing 32 mm (1.26") / Pitch 6		
X / Y axes thrust (Con.)	961.8 Kgf (2,117 lbs.) / 854.9 Kgf (1,880 lbs.)		

Specifications are subject to change without notice.

*1 Individual models may vary, please see interference drawings.

MACHINE SPECIFICATIONS 2

TAILSTOCK (OPTIONAL)	GS-200 / 200L	GS-260 / 260L	GS-280 / 280L
Quill center taper	MT#3 (Built-in spindle type, Live quill)		
Quill diameter / travel	Ø 85 mm (3.34") / 120 mm (4.72")		
Tailstock base travel*1	470 mm (18.50") / 1,070 mm (42.12")		
Programmable quill / base	Yes / Yes		
Programmable base type	Positioned by Z-axis carriage through user-friendly macro programming		
SUB-SPINDEL (OPTIONAL)			
Standard turning diameter	Ø 152 mm (6")		
Chuck size*2	Ø 6"		
Hole through spindle	Ø 46 mm (1.81")		
Spindle bearing diameter	Ø 80 mm (3.14")		
Hydraulic cylinder	6"		
Spindle nose	A2-5		
Spindle motor type	Fanuc α 112M / 15,000 iB (AC / Wide-range / Con. Output)		
Motor output (Con.)	5.5 kW (7.5 HP)		
Motor output (30 min.)	7.5 kW (10 HP)		
Motor full output speed	1,500 rpm		
Spindle drive system	Direct built-in motor (Integrated Motor)		
Spindle drive ratio	1 : 1		
Spindle speed range	60 ~ 6,000 rpm		
Spindle full output speed	1,500 rpm		
Spindle torque (Con.)	35 N-m (26 ft-lbs)		
Spindle torque (30 min.)	48 N-m (36 ft-lbs)		
B-axis travel*1	+ 30 mm, -570 mm (+ 1.18", - 22.44") / + 30mm, - 1,070 mm (+ 1.18" , - 42.12")		
B-axis rapid	24 m/min. (945 IPM)		
Slide way type	Hardened & Ground Box Ways		
B-axis servo motor	AC 3.0 kW (4.1 HP, Fanuc α 12 / 3,000 i , Absolute encoder, 1,000,000 / rev.)		
B-axis ball screw Ø / pitch	Ø 36 mm (1.41") / Pitch 10		
B-axis thrust (Con.)	769 Kgf (1,692 lbs.)		
MAIN SPINDEL PARTS CATCHER (OPTIONAL)			
Maximum part diameter	Ø 60 mm (2.36")		
Maximum part length	180 mm (7.08")		
Maximum part weight	4 Kg (8.8 lbs.)		

Specifications are subject to change without notice.

*1 Individual models may vary, please see interference drawings.

*2 Chuck optional.

GENERAL	GS-200 / 200L	GS-260 / 260L	GS-280 / 280L
Positioning accuracy (X / Y / Z / B)	+/- 0.005 mm (+/- 0.0002")		
Repeatability (X / Y / Z / B)	+/- 0.003 mm (+/- 0.0001")		
Standard CNC control	Fanuc Oi-TD		
Voltage / Power requirement	AC 200 / 220 +10% to -15% 3 phase / 26 KVA		
Hydraulic tank capacity	30 L (8 gal.)		
Coolant tank capacity	200 L (52.5 gal.)		
Coolant pump	0.5 kW (3/4 HP, 60 Hz) rated at 4.2 bar (60 PSI)		
Machine weight	4,800 Kg (10,560 lb.) / 5,600 Kg (12,320 lb.)		
Machine weight (MS models)	5,000 Kg (11,000 lb.) / 5,800 Kg (12,760 lb.)		
Dimensions L x W x H*1	Machine: 2,670 / 3,500 x 1,955 x 1,890 mm (106" / 138" x 77" x 75") Machine w / Y-axis: 2,670 / 3,500 x 1,920 x 2,260 mm (106" / 138" x 76" x 89")		

Specifications are subject to change without notice.

*1 Individual models may vary, please see drawings below.

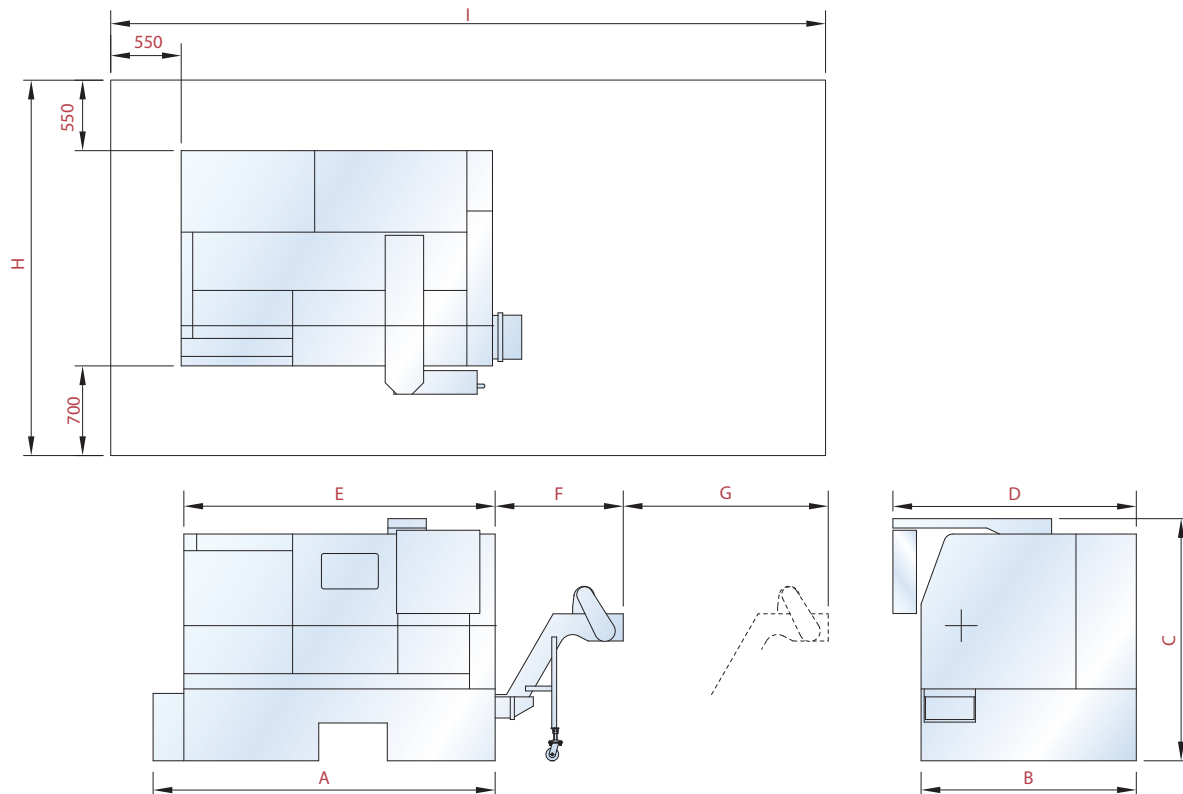

Models	A	B	C	D	E	F	G	H	I
GS-200 / 260 / 280	2,670 mm (105.2")	1,840 mm (72.4")	1,890 mm (74.5")	1,955 mm (77.0")	2,430 mm (95.7")	1,000 mm (39.4")	1,600 mm (63.0")	3,090 mm (121.6")	5,580 mm (219.7")
GS-200L / 260L / 280L	3,500 mm (137.8")	1,760 mm (69.2")	1,900 mm (74.9")	1,900 mm (74.9")	3,500 mm (137.8")	1,000 mm (39.4")	2,200 mm (86.7")	3,010 mm (118.5")	7,250 mm (285.5")
GS-200 / 260 / 280 (Y-axis)	2,670 mm (105.5")	1,730 mm (68.1")	2,260 mm (89.0")	1,920 mm (75.6")	2,430 mm (95.7")	1,000 mm (39.4")	1,600 mm (63.0")	2,980 mm (117.3")	5,580 mm (219.7")
GS-200L / 260L / 280L (Y-axis)	3,500 mm (137.8")	1,840 mm (72.4")	2,260 mm (89.0")	2,040 mm (80.3")	3,500 mm (137.8")	1,000 mm (39.4")	2,200 mm (86.7")	3,090 mm (121.6")	7,250 mm (285.5")

Specifications are subject to change without notice.



GOODWAY MACHINE CORP.

Headquarters :

No.13, 5Th Road,
Taichung Industrial Park,
Taichung City, 407, Taiwan, R.O.C.
TEL : + 886-4-2359-1226
Website : www.goodwaycnc.com
E-mail : goodway@goodwaycnc.com

GOODWAY (SUZHOU) MACHINE CORP.

No.589, Chengyang Road,
Xiang Cheng Economic Development District
Suzhou City, Jiangsu, China
TEL : + 86-512-6576-3699
FAX : + 86-512-6576-7299
Website : www.goodwaycnc.com.cn
E-mail : goodway.suzhou@goodwaycnc.com.tw

Central Taiwan Science Park Branch :

No. 38, Keyuan Road,
Central Taiwan Science Park.Taichung,
Taichung City, 407, Taiwan, R.O.C.
TEL : + 886-4-2463-6000
FAX : + 886-4-2463-9600